

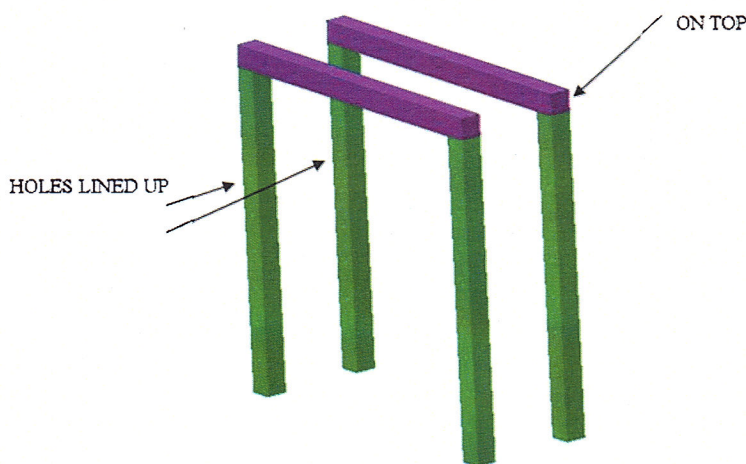

Problem 1.5.9a Playground Design Problem Teacher Support Document

Monkey Bar Sub Assembly

- Step 1: Open a new Assembly File
- Step 2: Place 2 "monkeybar" files into the assembly
- Step 3: Place 2 "uprightmonkeybar" files into the assembly
- Step 4: Place 2 "uprightmonkeyladder" files into the assembly
- Step 5: Use Constrain to "Mate" these pieces to create your monkey bars
 Note: the monkeybar files should be connected to the TOP of the upright files
 (see diagram)



Notice they may not be squared up yet. It's ok!

- Step 6: Place 21 monkeypoles into the assembly and "Insert" one into each set of holes.

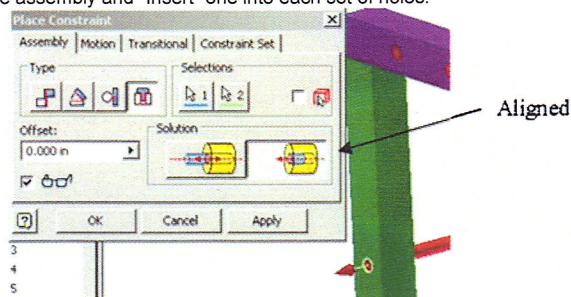

Once all bars are inserted, your monkey bars should similar to the picture below.

Notice one side has the ladder going all the way up while the other side only has a ladder going partially up. This will be important in the final assembly.



Save As: Monkey Bars

Platform Sub Assembly

- Step 1: Open a new Assembly File.
- Step 2: Place the "mainplatform" file & the "triplatform" file into the assembly.
- Step 3: Place 4 "mainpole" files into the assembly & Insert each pole into the 4 holes at the corners of the mainplatform.

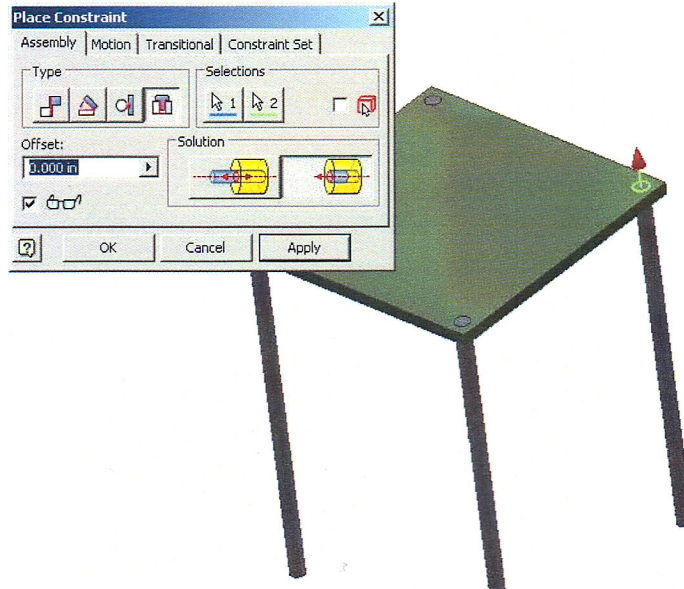

- Step 4: Place 2 "shortpole" files into the assembly & Insert into the 2 holes away from the largest corner of the triplatform.

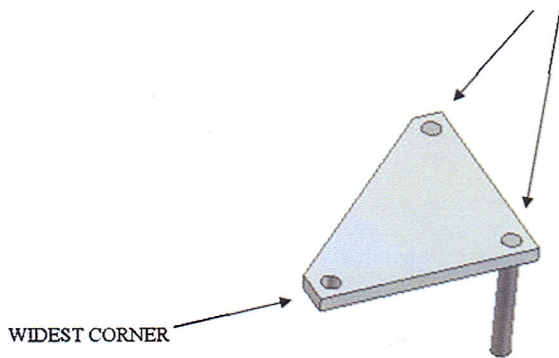

Step 5: Mate one of the short poles above one of the existing poles in the main platform. (see diagram below) Angle constrain in order to keep it squared up to your main platform.

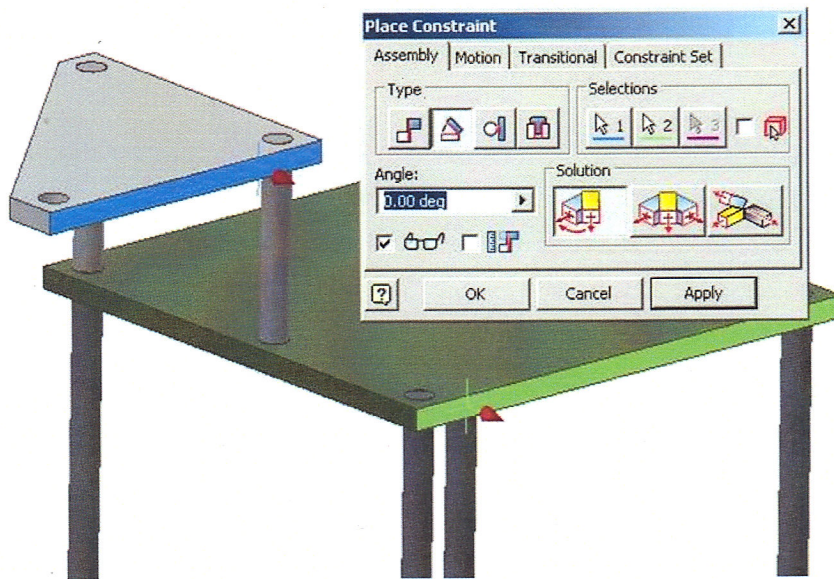

Step 6: Place the "longpole" into the assembly and Insert it into the hole in the corner of the triplatform piece. The bottom of this pole should be even with the other poles from the mainplatform.

PLATFORMS SUB-ASSEMBLY SHOULD LOOK SIMILAR TO THIS



Save As: Platforms Climbing Wall Sub Assembly

- Step 1: Open a new Assembly file.
- Step 2: Place the "wallclimb" file into the assembly.
- Step 3: Place as many "wallhandle" files into the assembly as necessary to fill each hole.
- Step 4: Insert wall handles into the holes on the wall until all holes are filled.

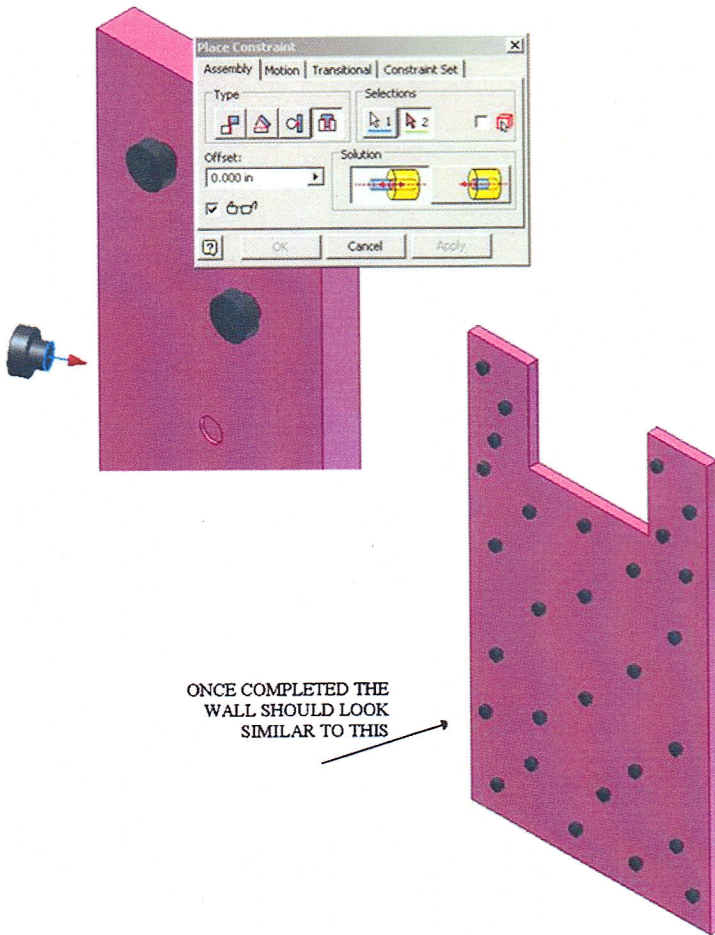

ONCE COMPLETED THE WALL SHOULD LOOK SIMILAR TO THIS

Save As: Climbing Wall Final Assembly

- Step 1: Open a new Assembly file.
- Step 2: Place the "Platforms" Sub-Assembly into the final assembly.
- Step 3: Place the "Climbing Wall" Sub-Assembly into the final assembly.
- Step 4: Mate the back of the climbing wall to the side of the main platform as shown below. (make sure your wall is on the correct side of the platform!)
- Step 5: Flush the side of the climbing wall to an adjacent side of the main platform as shown below.
- Step 6: Mate the top of the cut out portion of the climbing wall to the top of the main platform. By completing these 3 constraints, your wall should be fully constrained to the platform.

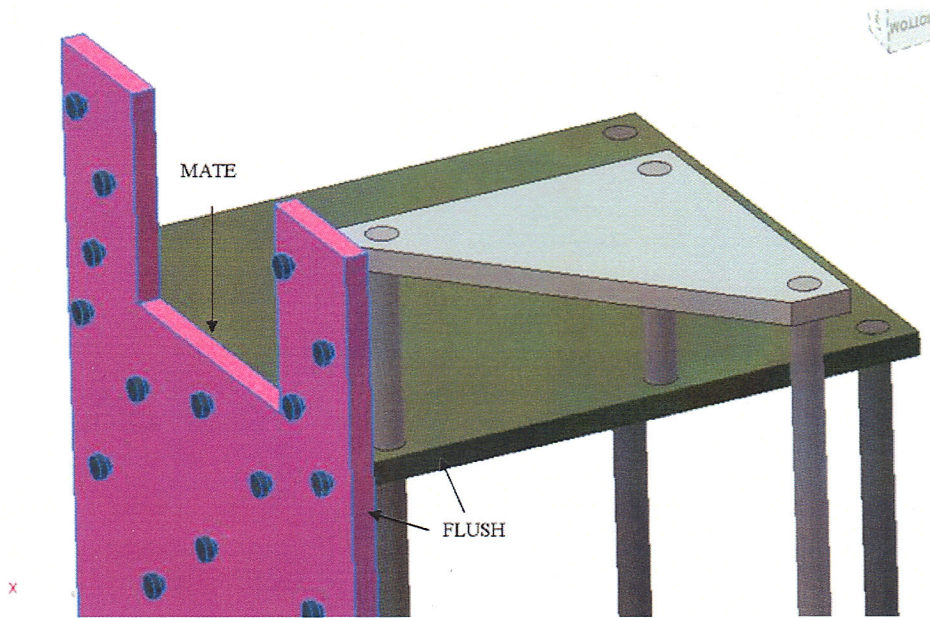

Save As: Final Assembly

Step 7: Place the "MonkeyBar" Sub Assembly into the Final Assembly.

Step 8: Mate the back of the tallest ladder side to the side of the main platform opposite the climbing wall as shown below.

Step 9: Mate the top edge of the ladder to the top edge of the platform.

Step 10: Flush the outside of the monkey bar beam to the side of the main platform AND offset 18" in order to center it on this side of the platform as shown below.

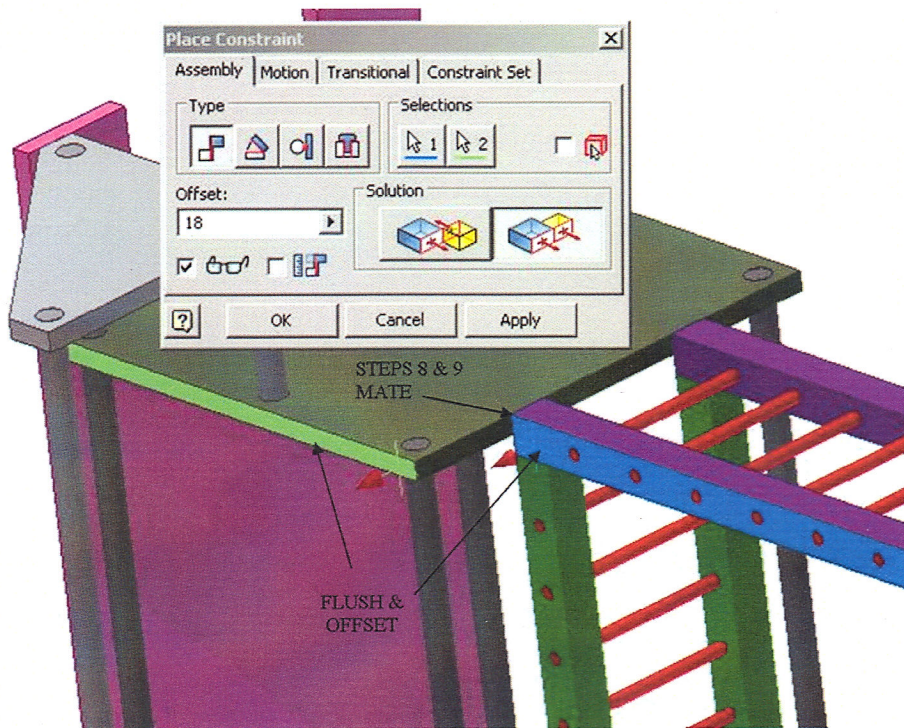

Save to update: Final Assembly

Step 11: Place the "Tunnelslide" into the final assembly.

Step 12: Mate the front of the tunnel slide to the side of the main platform as shown below.

Step 13: Flush the side of the tunnel slide to the side of the main platform AND offset 18" to center it on this side of the platform.

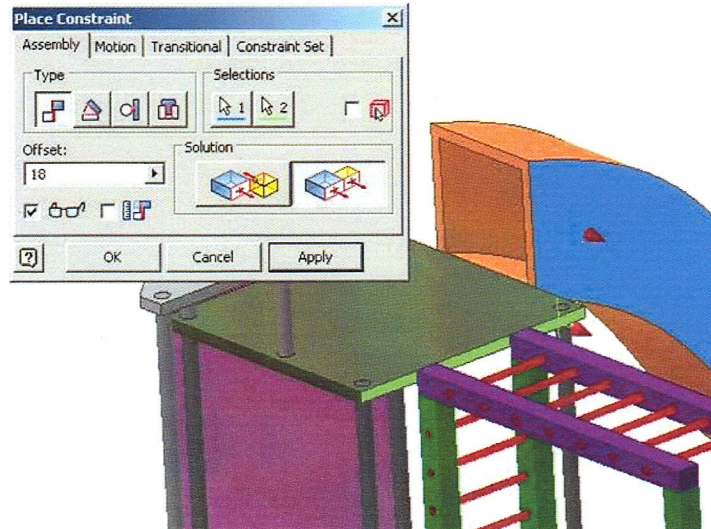

Step 14: Mate the bottom edge of the tunnel slide to the bottom edge of the platform as shown below.

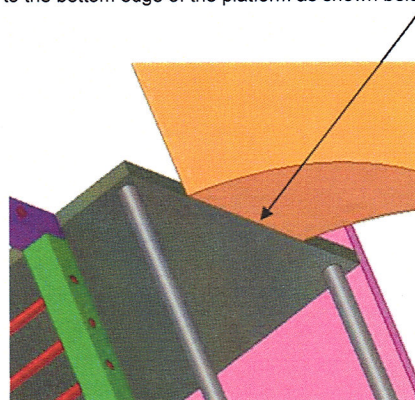

Save to update: Final Assembly

Step 15: Place the "slide" file into the final assembly.

Step 16: Mate the front of the slide to the side of the triplatform as shown below.

Step 17: Mate the top edge of the slide to the top edge of the platform AND offset 10" to make slide close to platform surface.

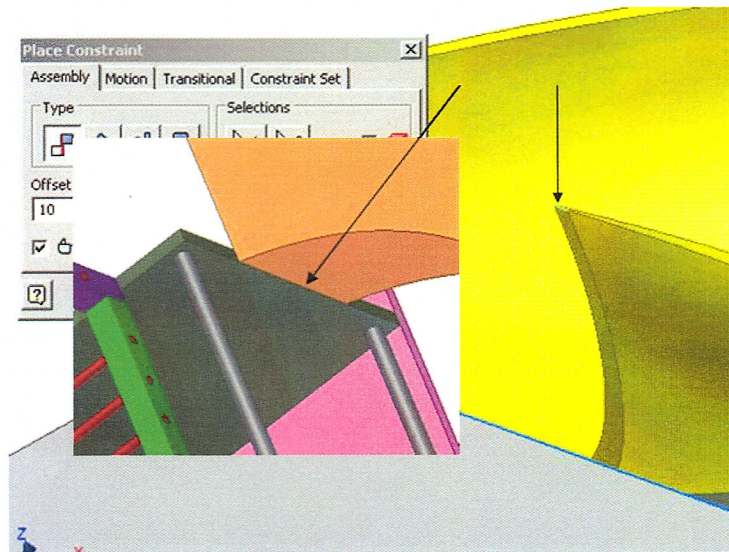

Step18: Tangent constrain the side of the platform and the inside of the slide as shown below. This will make the slide vertical and allow the long pole to be in the middle of the slide.

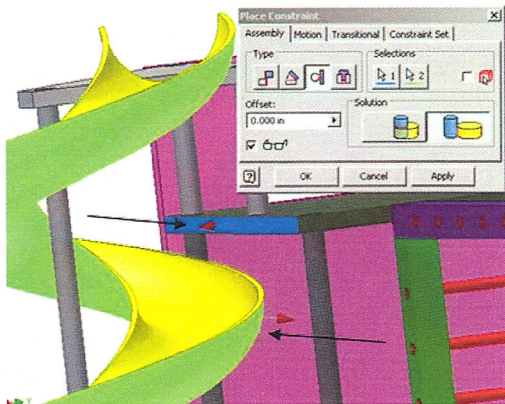

Save to update: Final Assembly

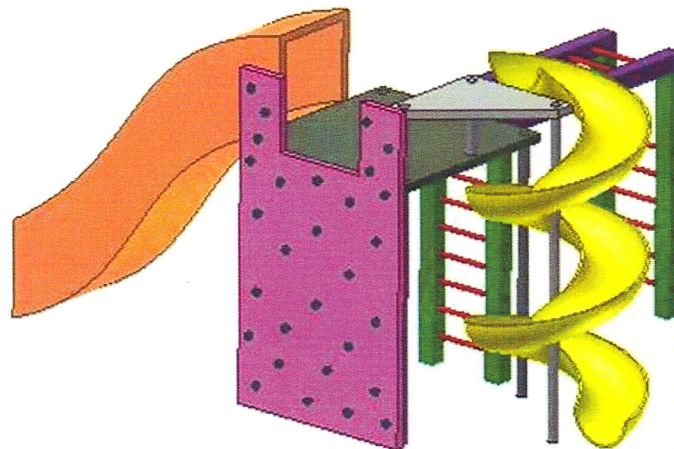

Your final assembly should look similar to this.

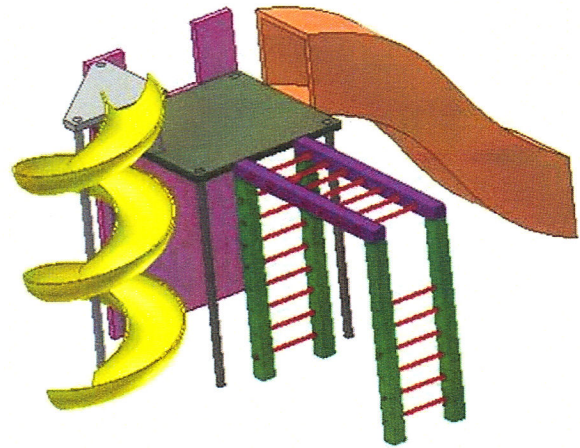

- Step 19: Place as many "Crayonpoles" as needed into the final assembly. These will be used for safety concerns around the edges of the both platforms.
- Step 20: In order to constrain the crayons to the platforms and keep them in line you must follow the following steps as shown.
- Step 21: Mate the bottom of the crayon pole to the top of the platform.
- Step 22: Mate the center axle of the crayon pole to one side of the platform AND offset 4" (note: it may be a -4" offset). (see screen shot)
- Step 23: Repeat Step 22 with the adjacent side of the platform and offset again 4" for any corner crayon poles.

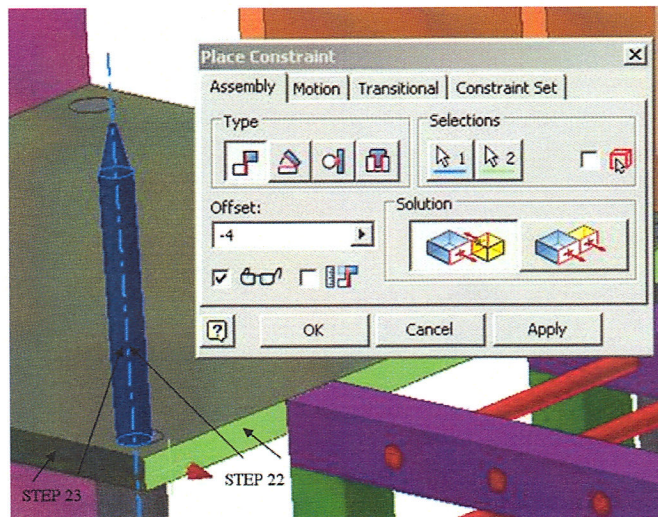

Step 24: If crayon poles are not in the corners, complete steps 21 and 22, but then you should Mate the crayon pole to another one next to it and offset 7.5" (center axle to center axle).

*Repeat Steps 21-23(4) until you have enough crayon poles to block any potential safety concerns. Crayon poles should be around 7-7.5 inches apart to eliminate a child sliding through.

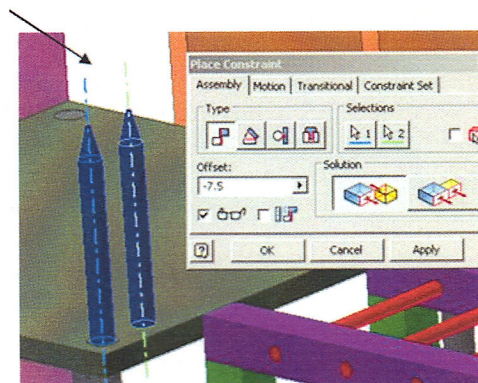

Save to update: Final Assembly

Congratulations on your new Play Set!

